

WAVECOM® W-PCle

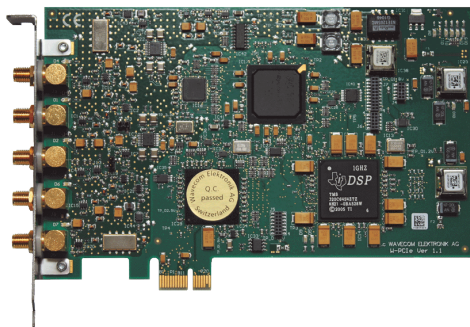

W-PCle offers two completely independent Digital Down Converter inputs (DDC) at IF and AF level, ideally suited for connection to narrow and broadband receivers and wideband down converters. With two lines of simultaneous and independent decoding on one card, W-PCle delivers a modern and compact solution with various interfaces in hardware and software and includes all functionalities of W-CODE.



W-PCIe

The Preferred Hardware Decoder

WAVECOM®
NACHRICHTENTECHNIK

W-PCIe Features and Facts

- ◆ W-PCIe offers two high-quality DDC inputs with wideband frequency range. The DDCs extract the narrow-band signal of interest from a broad-band input signal. The extracted signal is then used for further analysis, decoding and recording.
- ◆ W-PCIe card does not need a USB license dongle. The key is integrated in the card.
- ◆ W-PCIe provides all functions required to analyze, decode, record and process radio data communications throughout the radio spectrum from HF, VHF, UHF to SHF.
- ◆ W-PCIe includes all functionalities of W-CODE.
- ◆ Two lines of decoding on one card: genuine simultaneous dual channel decoding of two different signals.
- ◆ W-PCIe supports automatic classification, code check, demodulation and decoding to content level (text, live voice and image etc.) of signals and predefined unknown signals.
- ◆ The easy-to-use graphical user interface (GUI) with well-structured pull-down menus allows an operator to rapidly become familiar with W-PCIe.
- ◆ A W-PCIe card may be controlled from anywhere via the Internet, an Ethernet LAN or a W-LAN.
- ◆ W-PCIe supports remote control from other applications using third party software with TCP/IP and XML.
- ◆ W-PCIe card can be used as a wide-band signal recorder with direct antenna or 70 MHz IF connection.
- ◆ The implementation of complex systems for monitoring is limited only by the performance of the hardware and software.
- ◆ System components can be individually configured according to the requirements of the customer.

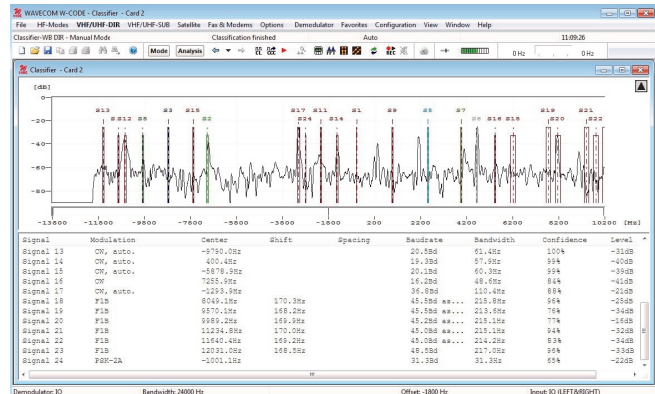

Classifier-WB display containing 24 identified signals

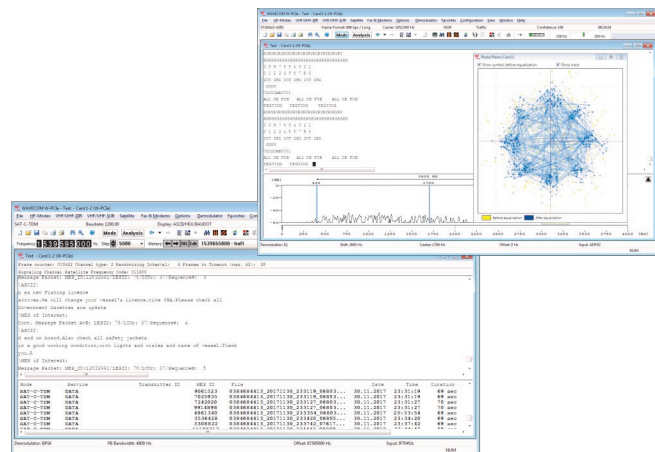

Simultaneous dual channel decoding on one W-PCIe card: STANAG-4285 on AFIF#2 (channel 2) and SAT-C-TDM on IF70#1b (channel 1)

Signal Sources and Devices

- ◆ The application processing the input from W-PCIe is the same as W-CODE. The Device Selector supports a great number of input interfaces and devices. W-PCIe supports dual IF inputs from 0 – 25 MHz or 70 MHz +/- 17.5 MHz
- ◆ W-PCIe is a universal signal interface and may be installed in any PC with PCIe x1 card slots
- ◆ A number of other interfaces, e.g. SDR I/Q data or digital TCP/IP input streams using W-CLOUD, IP-PXGF, Virtual Audio Cable (VAC) or WiNRADiO Digital Bridge Virtual Sound Card (VSC) are also available with W-PCIe

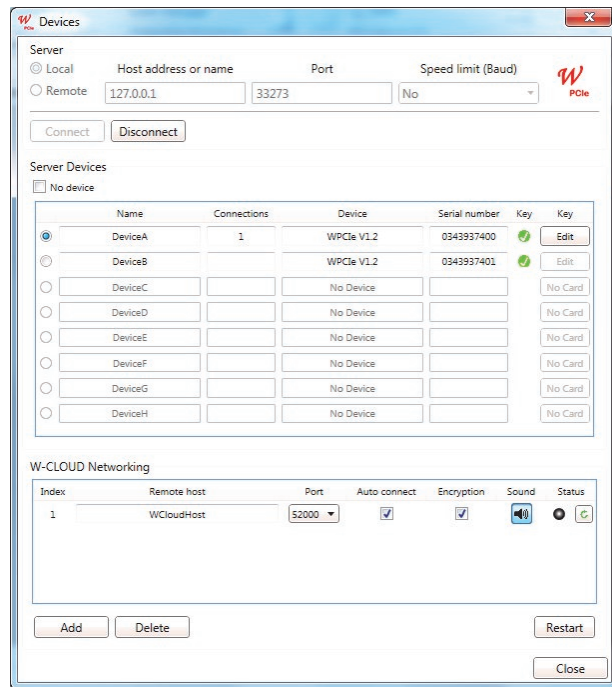

Device Selector in W-PCIe: one card is listed as two decoder instances for simultaneous decoding

- ◆ W-PCIe is configured with two independent Digital Down Converters (DDC) corresponding to the well-known Software Defined Radio (SDR) technology

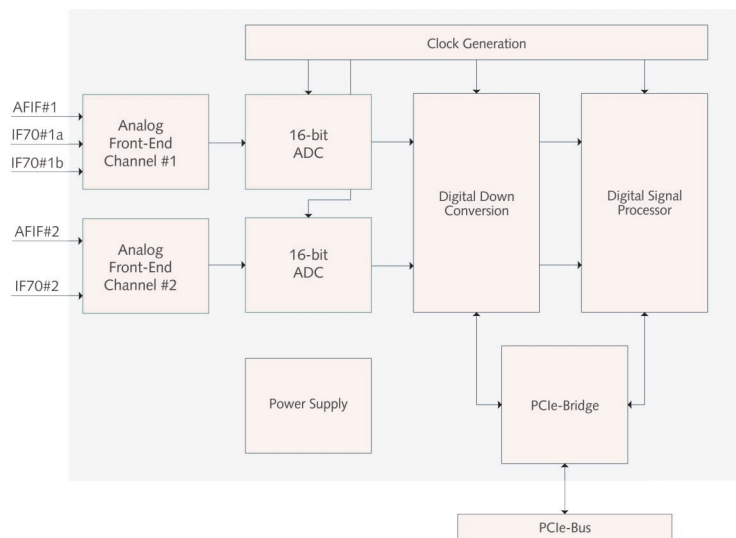

W-PCIe block diagram

Wide Range of Application

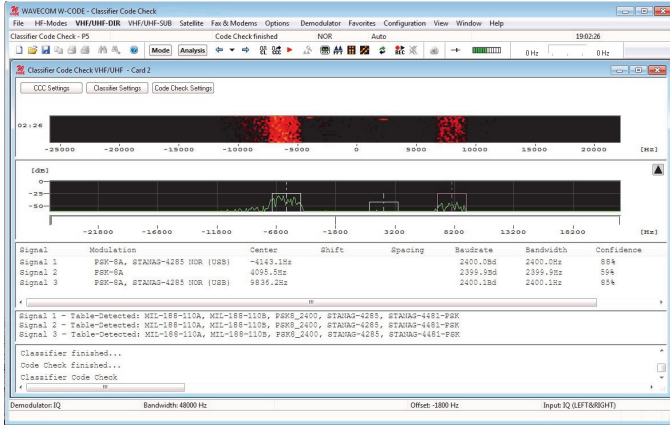

Automatic Signal Classification

Data Decoding

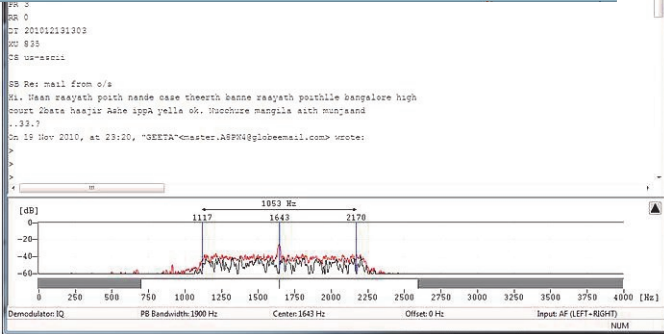

Signal Analysis

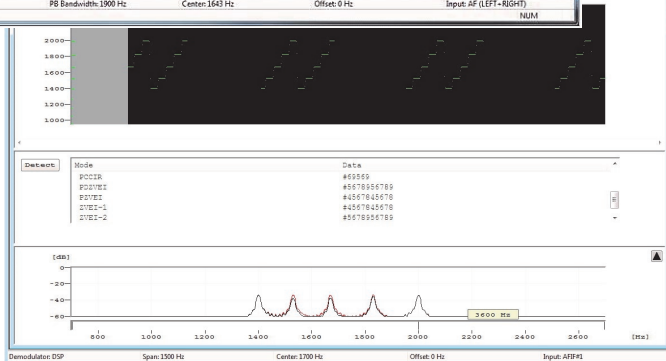

Bit Analysis

- Extraction (Mask)
- test STANAG 4285 Descrambler
- test Symbol Transcoding
- Extraction (Mask)
- test STANAG-4285 DeInterleaver
- test Stream setup for Viterbi
- Viterbi
- Mirroring
- ASCII
- UTF-8

Practical Application

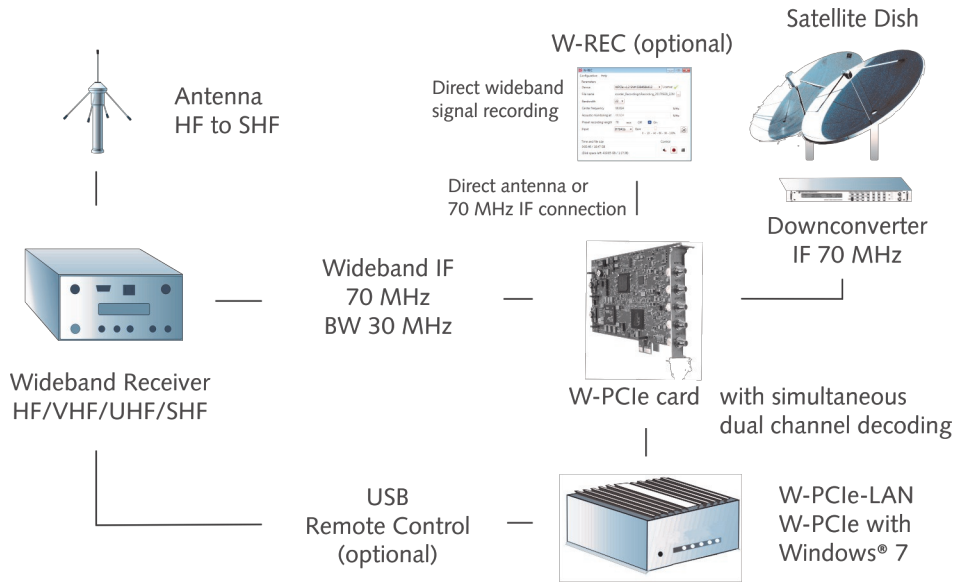

W-PCIe and wideband receiver configuration with optional direct wideband recording W-REC

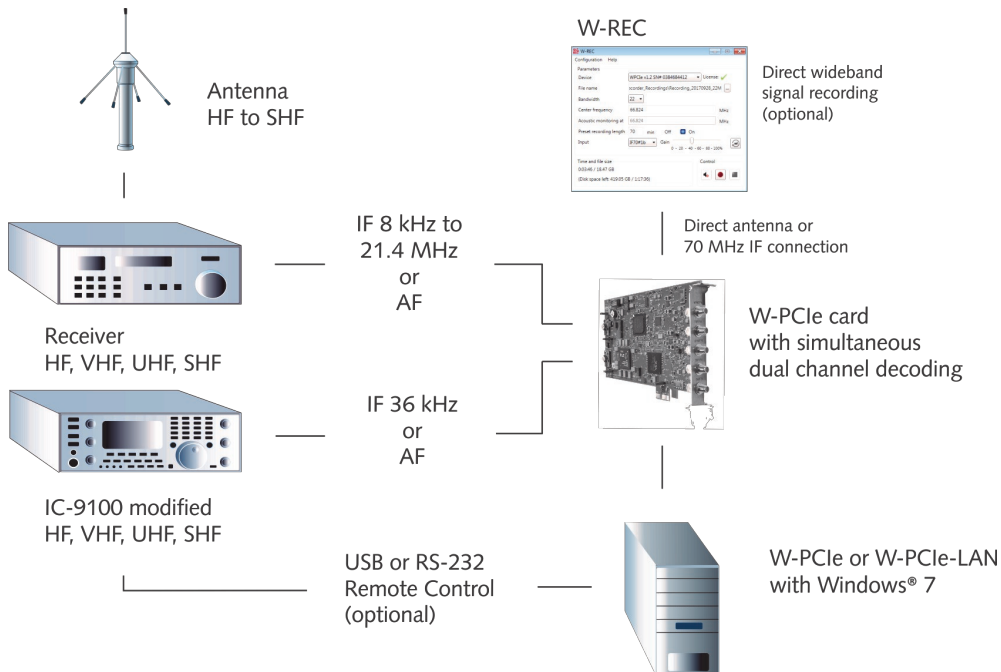

W-PCIe and IF or AF configuration with direct wideband recording W-REC

Satellite Application

Inmarsat monitoring is an integral part of the wide range of modes available for the Wavecom suite of decoders. W-PCIe decoder functions include



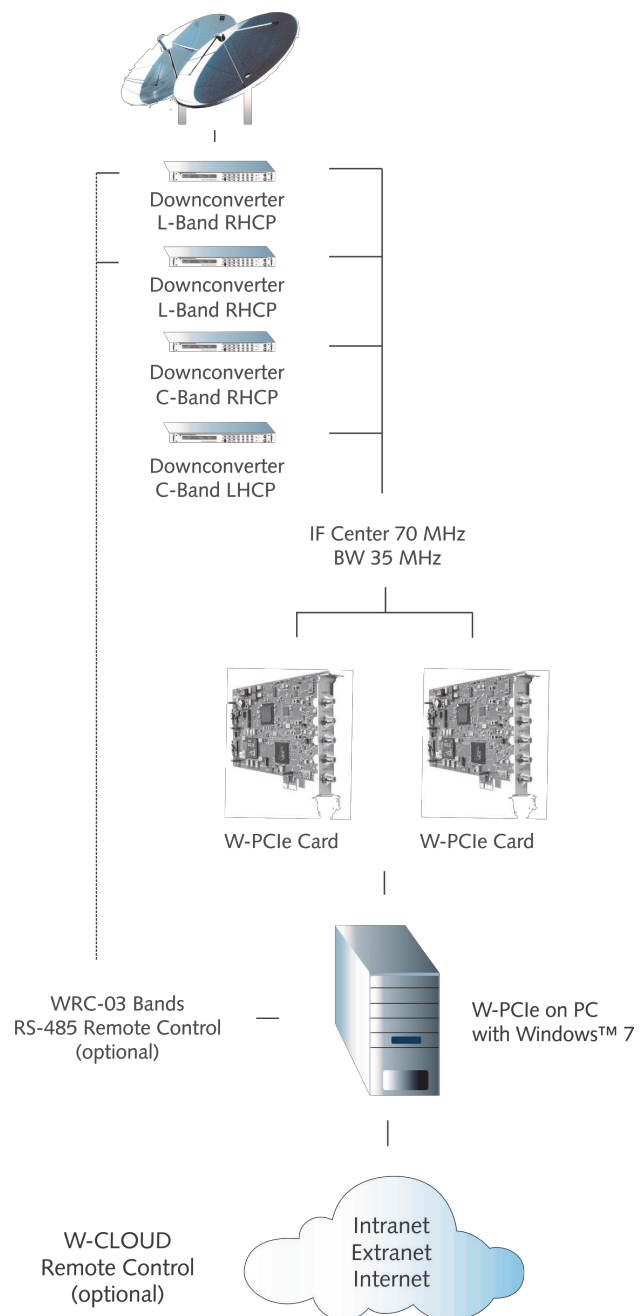

- ◆ Real-time voice (Inmarsat B and M), data and fax decoding
- ◆ SAT-AERO decoding
- ◆ Remote control interface enabling customers to build their own customized monitoring system
- ◆ Output can be fed to optional W-SAT-email decoder

The Inmarsat system covers four ocean regions, each served by a satellite. A Network Coordination Station (NCS) in each region assigns a free traffic frequency, timeslot or logical channel to the session between the Mobile Earth Station (MES) and the Land Earth Station (LES). After the session has terminated, the frequency, time slot or logical channel is returned to the common resource pool.



W-PCIE Card Specifications and Technical Data

| | | |
|----------------------------|--|-----------------------------------|
| Inputs | AFIF#1 and AFIF#2 | IF70#1a, IF70#1b and IF70#2 |
| Connector | SMA female | SMA female |
| Frequency range | 50 Hz to 25 MHz | 52.5 MHz to 87.5 MHz (SAW filter) |
| Bandwidth | 5 kHz to 500 kHz | 5 kHz to 500 kHz |
| Frequency raster DDC | 1.0 Hz | 1.0 Hz |
| Signal level | 2 mVrms to 0.5 Vrms 20 mVrms to 2.5 Vrms with 20 dB attenuator (jumpered) | 20 mVrms to 2.5 Vrms |
| Input impedance | > 1 kOhm | 50 Ohm |
| Input max sampling rate | 92.16 MHz | 92.16 MHz |
| Input sampling rate jitter | 1 ps (RMS 12 kHz to 20 MHz) | 1 ps (RMS 12 kHz to 20 MHz) |
| Available for mode group | HF / VHF / UHF / Fax and Modem | HF / VHF / UHF / SAT |

| | |
|--|--|
| Card type | Half-size PCIe card (PCI Express) |
| Number of concurrent, independent inputs | 2 AFIF#1 or IF70#1a or IF70#1b -with- AFIF#2 or IF70#2 |
| Dimensions (L x W x H) | 168 x 106 x 22 mm |
| Weight | 0.15 kg |
| Power requirement (typical values) | +3.3V max. 1.0 A +12V max. 0.5 A |
| Bus interface | PCIe x1 Link 2 Gbit/s |
| Operating temperature range | 0 °C to 50 °C |
| Case temperature range | 0 °C to 55 °C |
| Storage temperature range | 0 °C to 70 °C |
| Relative humidity | 10 to 90 % (non-condensing) |
| A/D converter | AD9268 dual 16 bit ADC |
| Dynamic range | > 60 dB |
| Digital down converter DDC | FPGA Cyclone IV 55K |
| DSP | TI DSP320C6454 |
| Watchdog for on-board generated voltages | Yes |
| Conformity |     |

W-PCIe

The Preferred Hardware Decoder

WAVECOM[®]
NACHRICHTENTECHNIK

Since more than thirty years Wavecom Elektronik AG has developed, manufactured and distributed high quality devices and software for the decoding and retrieval of information from wireless data communication in all frequency bands. The nature of the

data communication may be arbitrary, but commonly contains text, images and voice. The company is internationally established within this industry and maintains a longstanding, world-wide network of distributors and business partners.

Product Information

| | |
|-------------------|---|
| Products | http://www.wavecom.ch/product-summary.php |
| Datasheets | http://www.wavecom.ch/brochures.php |
| Specifications | http://www.wavecom.ch/product-specifications.php |
| Documentation | http://www.wavecom.ch/manuals.php |
| Online help | http://www.wavecom.ch/content/ext/DecoderOnlineHelp/default.htm |
| Software warranty | One year free releases and bug fixes, update by DVD |
| Hardware warranty | Two years hardware warranty |
| Prices | http://www.wavecom.ch/contact-us.php |

System Requirements and Ordering Information

| | <i>Minimum</i> | <i>Recommended</i> |
|--------|----------------------------|-----------------------------|
| CPU | Core i5 or Core i7 2.8 GHz | Core i7-6700 3.4 GHz |
| Memory | 4 - 8 GB RAM | 16 - 32 GB RAM |
| OS | Windows 7 | Windows 10 32-bit or 64-bit |

| Product Code | Description |
|--------------|---|
| WPCIE | Dual channel PCI Express x1 bus PC card with decoder software on an in-card license |
| WPCIESW | Decoder software on an in-card license. Software only, W-PCIe card not included |
| WLV | Vocoder live voice output to the speaker. Option for W-CODE, W74PC, W-PCIe, W-PCI and W-SPECTRA |
| WCPT | Decryption option to get clear voice and text. For W-CODE, W74PC, W-PCIe, W-PCI and W-SPECTRA |
| WHWL2 | Second license for simultaneous decoding. Available for W-PCI, W-PCIe and W74PC cards |

Distributors and Regional Contacts

You will find a list of distributors and regional contacts at <http://www.wavecom.ch/distributors.php>

WAVECOM[®]
NACHRICHTENTECHNIK

WAVECOM ELEKTRONIK AG
8090 Zurich, Switzerland
E-Mail: sales@wavecom.ch
Internet: www.wavecom.ch

© WAVECOM ELEKTRONIK AG - Brochure 2026 - All rights reserved

Microsoft, Encarta, MSN and Windows are either registered trademarks or trademarks of Microsoft Corporation in the United States and/or other countries. WINRADIO[®] is a registered trademark of Radixon Group Pty. Ltd. and Rosetta Laboratories Pty Ltd. ICOM[®] logo is a registered trademark of Icom Incorporated (Japan) in Japan.